

Hard diffraction in PYTHIA8

Christine O.Rasmussen

- PYTHIA8
- Soft diffraction
- Hard diffraction
- Preliminary results
- Conclusion and outlook

PYTHIA8 is a general purpose event generator for high-energy collisions.

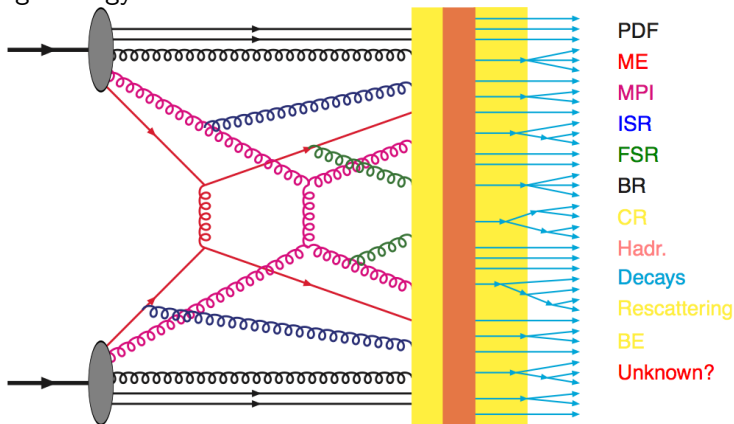

It attempts to describe all parts.

[Figure: T. Sjöstrand]

And does a fairly good job for most of the physics:

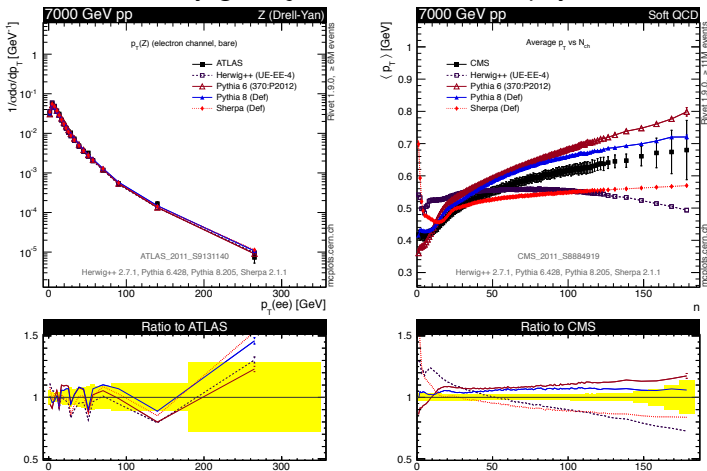

Figures from MCPlots: mcplots.cern.ch

PYTHIA8

Currently 8 authors (incl. 3 post-docs and 2 PhD students).

New main features as of version 8.2:

- New models of colour reconnections
(J. Christiansen, P. Skands + T. Sjöstrand)
- Variety of matching and merging schemes
(S. Prestel + L. Lönnblad)

Ongoing work:

- New PDF for photons for e^+e^- studies
(I. Helenius + T. Sjöstrand)
- New model for hard diffraction
(C. Rasmussen + T. Sjöstrand)

An Introduction to PYTHIA8.2

[\[Comput.Phys.Commun. 191 \(2015\) 159\]](#)

Soft diffraction

The soft diffractive PYTHIA8 machinery is based on the Ingelman-Schlein picture of a Pomeron as a hadronlike state.

$\mathbb{P}p$ and $\mathbb{P}\mathbb{P}$ collisions are here developed to also include the interleaved parton evolution of MPI, ISR and FSR.

MPI gives a smooth merging of hard jets and soft events.

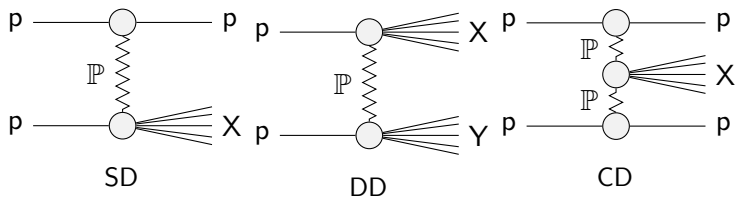

Soft diffraction

Low-mass region:

$$M_X \leq 10 \text{ GeV.}$$

- Represent M_X as longitudinal string
- Probability to take out a gluon or quark from Pomeron: $\frac{P(q)}{P(g)} = \frac{N}{M^p}$, p tunable
- Quark = 1 string, gluon = 2 strings
- No ISR, FSR, MPI
- Fragment with Lund String fragmentation model

High mass region:

$$M_X > 10 \text{ GeV.}$$

- Based on Ingelman-Schlein approach
- Set up $\mathbb{P}\mathbb{P}$ system
- MPI machinery decide interactions
- Includes interleaved MPI, ISR, FSR evolution in $\mathbb{P}\mathbb{P}$ system
- Now includes 7 models for Pomeron flux and 5 for Pomeron PDF

Soft diffraction

σ_{SD} with Pomeron-based parametrisation of Schuler-Sjöstrand:

$$\frac{d^2\sigma_{SD}}{dt dM^2} = \frac{g_{3P}}{16\pi} \beta_{AP} \beta_{BP}^2 \frac{1}{M^2} \exp(B_{SD} t) F_{SD}$$

MPI activity in SD tuned to give approximately same amount as in ND:

$$\langle n_{MPI} \rangle (ND) \sim \frac{\sigma_{hard}}{\sigma_{ND}} \Rightarrow$$

$$\langle n_{MPI} \rangle (SD) \sim \frac{\sigma_{hard}(\text{No gap survival})}{\sigma_{PP}(\text{No gap survival})} = \frac{\sigma_{hard}}{\sigma_{PP}^{eff}}$$

with $\sigma_{PP}^{eff} = 10$ mb, tunable.

Gap always survives, as MPI not allowed between Pomerons hadron-remnant and other hadronic remnant.

Soft diffraction

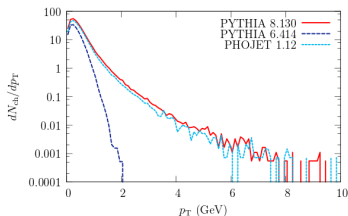

p_T distribution for SD events at 7 TeV. From S. Navin
[\[arXiv:1005.3894\[hep-ph\]\]](https://arxiv.org/abs/1005.3894).

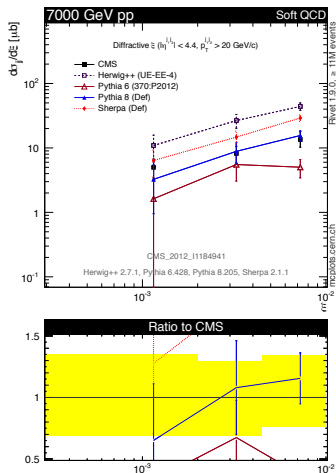

From MCPlots [\[mcplots.cern.ch\]](http://mcplots.cern.ch)

Hard diffraction

Objective: Given a hard scattering, $ab \rightarrow cd$, what is the probability for this to have been created in a diffractive process?

Available: Parton id, x and Q^2 .

Method: Evaluate the diffractive structure function and use dynamical gap survival.

Assumption 1: The hadronic PDFs can be split into non-diffractive and diffractive.

$$f_i(x, Q^2) = f_i^{\text{ND}}(x, Q^2) + F_i^{\text{D}}(x, Q^2)$$

Assumption 2: The diffractive structure function factorises.

$$F_i^{\text{D}}(x, Q^2) = \int_x^1 \frac{d\xi}{\xi} \int_{t_{\min}}^{t_{\max}} dt f_{\mathbb{P}/p}(\xi, t) f_{i/\mathbb{P}}(x/\xi, Q^2)$$

Hard diffraction

Only flux is t -dependent, hence we integrate t out:

$$f_{\mathbb{P}/\mathbb{P}}(\xi) = \int_{t_{min}}^{t_{max}} dt f_{\mathbb{P}/\mathbb{P}}(\xi, t)$$

with mass-dependent limits, $t = t(m_A^2, m_B^2, m_{A'(X)}^2, m_{X(B')}^2)$.

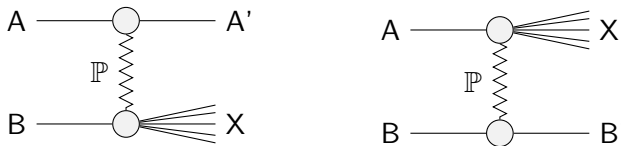

The probabilities for either sides to be diffractive are

$$P_B = F^D(x_a, Q^2) / f_p(x_a, Q^2)$$

$$P_A = F^D(x_b, Q^2) / f_p(x_b, Q^2)$$

Hard diffraction

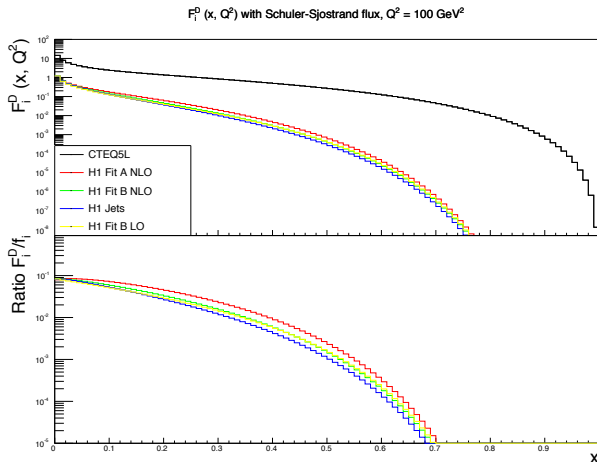

The diffractive structure function.

Hard diffraction

Dynamical gap survival:

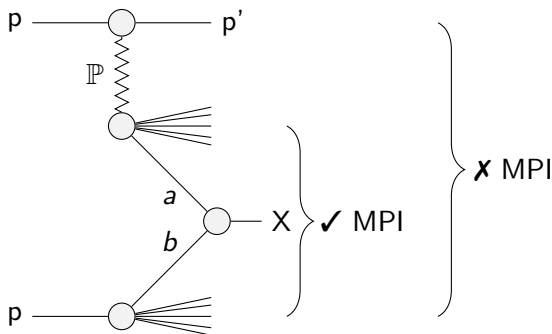

SD $ab \rightarrow X$ process with beam remnants from both proton and Pomeron.

Hard diffraction

Dynamical gap survival:

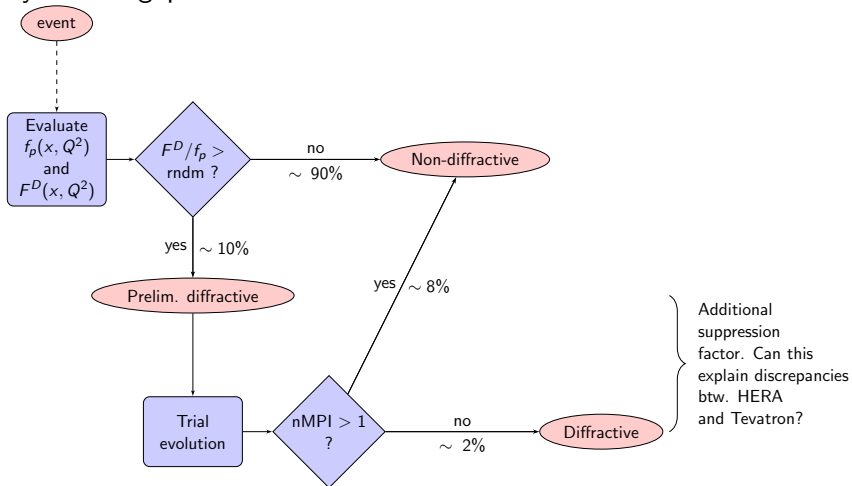

Diffractive dijet production at the Tevatron.

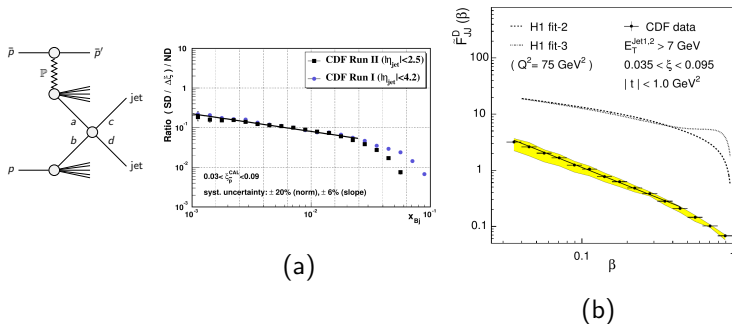

- (a) The ratio SD/ND dijet events at $\sqrt{s} = 1.8$ and $\sqrt{s} = 1.96$ TeV from CDF [[Phys.Rev.D86.\(2012\) 032009](#)].
- (b) The diffractive structure function measured at $\sqrt{s} = 1.8$ TeV from CDF [[Phys.Rev.Lett.84.\(2000\) 5043](#)]

Preliminary studies

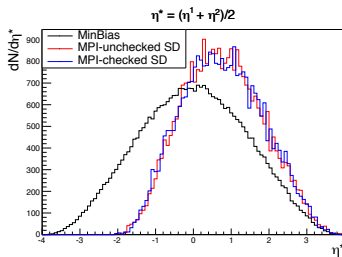
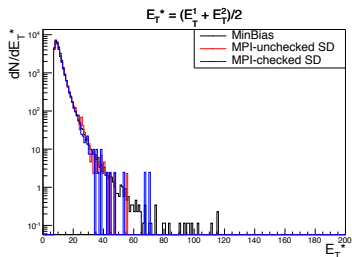
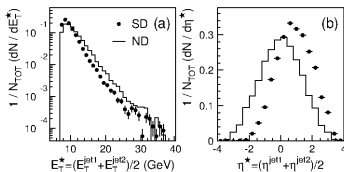

Preliminary studies

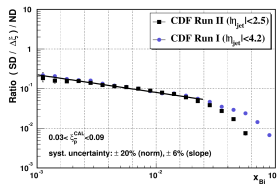
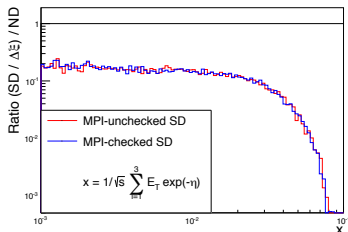

Events too hard \Rightarrow ratio not steep enough.
We need to suppress hardest events.

Preliminary studies

Solutions: New Pomeron fluxes and/or PDFs.

Test: Suppress Pomeron PDFs.

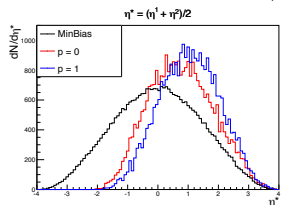
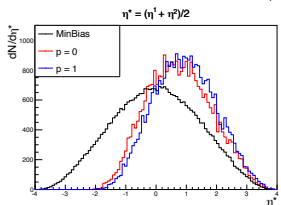
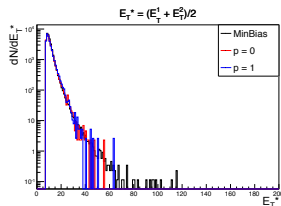
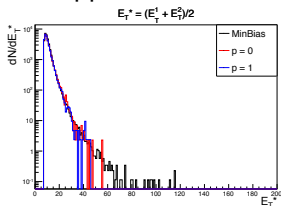

Suppression with $(1 - x)^P$

Suppression with x^{-P}

Preliminary studies

D0	$p\bar{p} \rightarrow \text{Gap} + W$ ($0.89^{+0.19}_{-0.17}$) %	$p\bar{p} \rightarrow \text{Gap} + Z$ ($1.44^{+0.61}_{-0.52}$) %
CDF	$p\bar{p} \rightarrow \bar{p}' + W$ (1.0 ± 0.11) %	$p\bar{p} \rightarrow \bar{p}' + Z$ (0.88 ± 0.22) %
PYTHIA8 MPI-checked	$p\bar{p} \rightarrow \bar{p}' + W$ $\sim 1.7\%$	$p\bar{p} \rightarrow \bar{p}' + Z$ $\sim 2\%$

Fractions are too large.

D0: [\[Phys.Lett.B574\(2003\)169\]](#)

CDF: [\[Phys.Rev.D82\(2010\)112004\]](#)

Conclusion

- We have developed a new model for hard diffraction with dynamical gap survival
- Model is implemented in PYTHIA8, publicly available (but still being tested)
- Model gives a factor ~ 2 larger fractions for diffractive W/Z than observed
- Kinematical distributions disagree with CDF data - we obtain too hard events
- Development of new Pomeron flux and/or PDF might solve the problems. On to-do list for Autumn
- LHC studies on to-do list. Comparison to eg. CMS feasibility studies [[CMS PAS DIF-07-002](#)].